

ULTIFRESH.NET

we deliver fresh apparels

Follow Us @:



Website



Facebook



Instagram

Visit Us @:

<https://www.ultifresh.net>

ULTIFRESH

Apparels

Anti-Bacterial | Anti-Odor

Vol. 6
2022/2023



Designed in Singapore



NEW!

**UDF0202 : BLACK
SPORTS SINGLET**

**HOT
SELLING!**



2022 - 2023

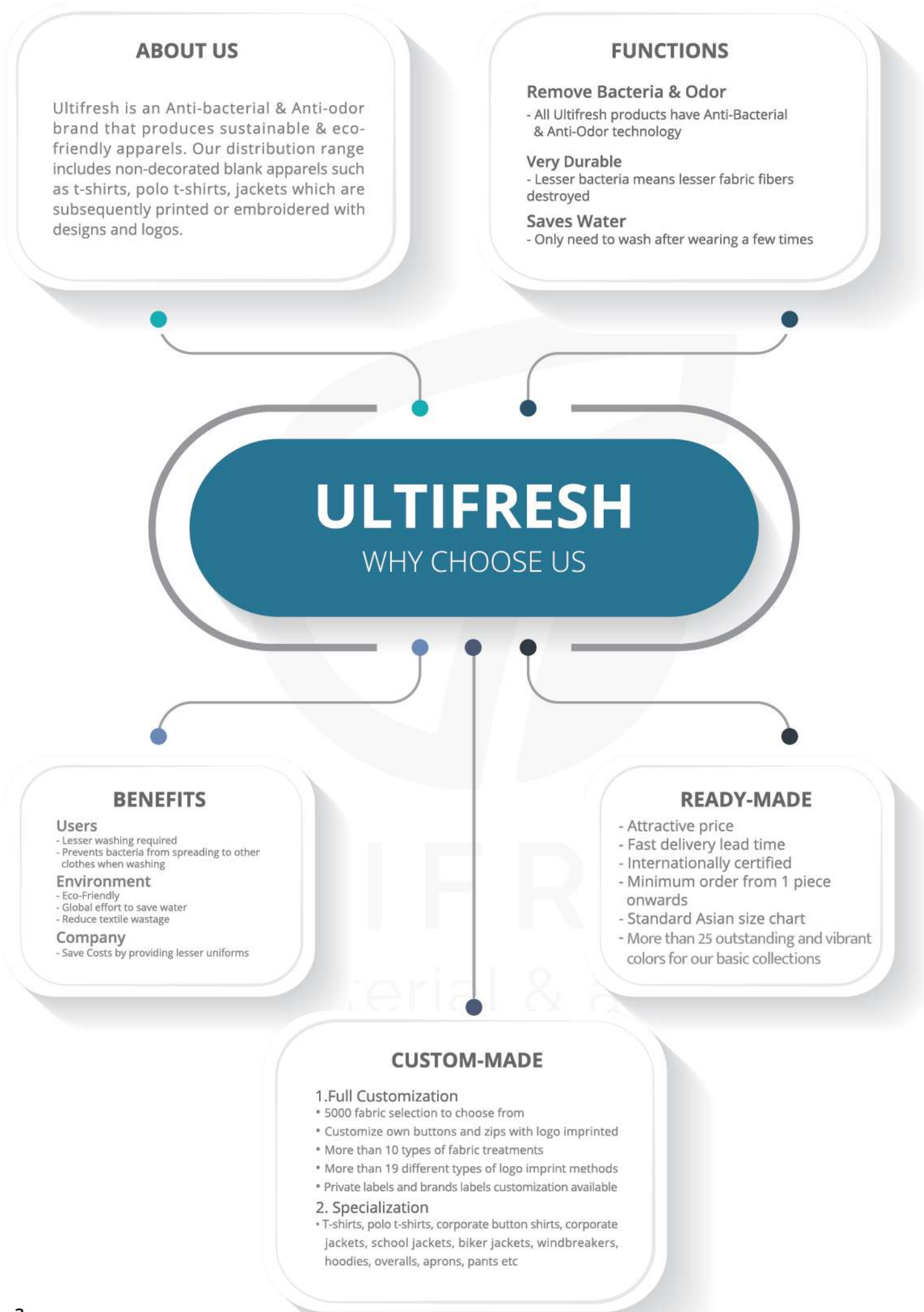

ABOUT ULTIFRESH

Ultifresh is a patented fabric technology that kills 99.94% bacteria permanently. The anti-bacterial & anti-odor features can be integrated into any fabric without affecting the outlook and the hand feel of the apparel.

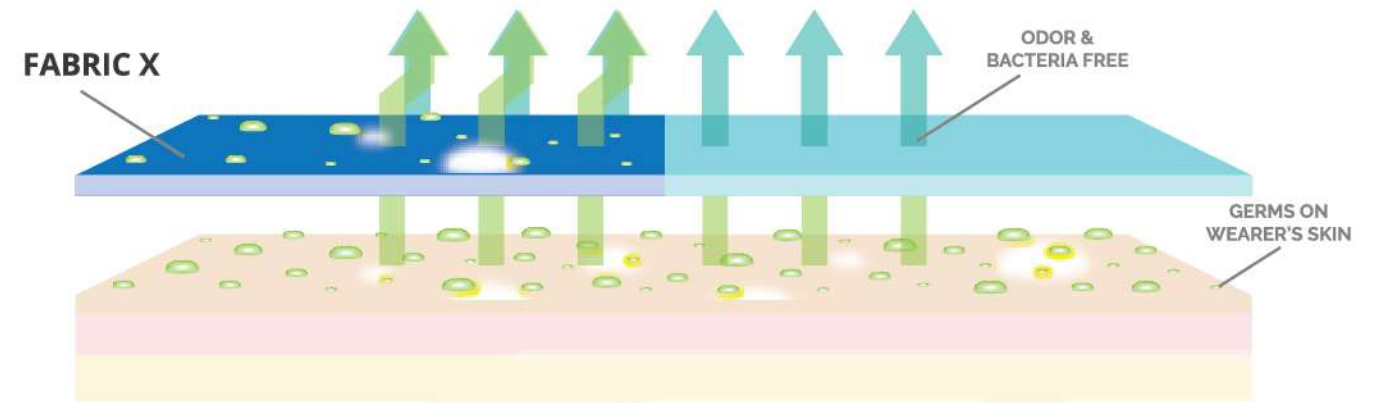

BENEFITS OF ULTIFRESH

Ultifresh products are designed with copper's anti-microbial properties, allowing it to self sterilize. It can also prevent bacteria growth, making it a safer apparel for everyone.



ANTI-ODOR

Ultifresh technology eliminates odor causing germs on the fabric itself, leaving the wearer fresh all day long.



INCREASED DURABILITY

Ultifresh prevents microbes from living on the apparel. Thus, it increases the longevity of the apparel, resulting into lesser textile wastage each year.



ANTI-BACTERIAL

We come into contact with thousands of unseen bacteria everyday. Ultifresh fabric solution kills bacteria minutes upon contact.



SAVES WATER

Ultifresh apparels require lesser washing cycles and reduces water usage by up to 75%! This unique feature allows the wearer to save water without compromising on safety.



COST SAVING

Ultifresh lowers the turnover of uniforms and apparels due to its durability, which allows wearer to wear longer without washing.



ECO - FRIENDLY

Ultifresh supports the global Go-Green effort in conserving the Earth's natural resources such as water and reducing textile wastage.

CONTENT

	Latest Collection	1 - 2
	Why Choose Ultifresh	3
	About Ultifresh	4
01	<u>Ultifresh Performance Series</u>	
	Crew Neck	9 - 13
	Polo T-Shirt	14 - 16
	Sports Singlet	17 - 18
	Sports Shorts	19 - 20
02	<u>Ultifresh Design Series</u>	
	Contrast Series	21 - 28
	Oriental Series	29 - 30
	Heather Series	31 - 32
	Hybrid Series	33 - 36
	Double Pique Series	37 - 40
03	<u>Ultifresh Outerwear Series</u>	
	Bomber Jacket	41 - 42
	Full Moon Zip Up Jacket	43 - 44
	Varsity Jacket	45 - 46
04	<u>Ultifresh Reusable Mask Series</u>	
	Reusable Mask	47 - 49
	Filter Sheet	50
05	<u>Ultifresh Towel Series</u>	
	Anti-Bacterial Quick-Dry Towel	51 - 52
06	<u>BEAM Series</u>	
	Collar Fleece Zip Up Pocket	55 - 56
	Hoodie Without Zip	57 - 58
	Hoodie With Zip	59 - 60
	Jacket In A Bag	61 - 62
	Soft Cardigan	63
	V-Neck Sweater	64
	Cotton Polo T-Shirt	65 - 66
	Cotton Short Sleeve T-Shirt (Unisex)	67 - 69
	Cotton Short Sleeve T-Shirt (Kids)	70
	Polyester Apron	71 - 72
	Long Sleeve Sweat Shirt	73 - 74
	Oxford Corporate Shirt	75 - 76
	Corporate Long Sleeve Button Shirt	77 - 78
	Corporate Short Sleeve Button Shirt	79 - 80
	Corporate Blazer, Pant & Skirt	81 - 84
07	<u>Ultifresh Promotional Series</u>	
	Performance Series	86 - 87
	Hybrid Series	88
	Oriental Series	89
	Double Pique Series	90
08	<u>Ultifresh Customization</u>	91 - 92





ULTIFRESH PERFORMANCE

Ultifresh makes you feel comfortable the way it is meant to be. #feelgood



UDF2202
Black

SGS **intertek**
Total Quality. Assured.
TEST REPORT

- 100% Performance Dri-Fit Polyester
- Microfiber Polyester Eyelet

ULTIFRESH
anti-bacterial & anti-odor



Anti Bacterial & Anti-Odor Finishing

Self Fabric Collar



UDF22 CREW NECK T-SHIRT (KIDS)

Size	Shoulder	Chest	Sleeve	Length
24"	11.5"	25"	4.5"	15.5"
26"	12"	27"	5"	17"
28"	12.5"	29"	5.5"	18.5"
30"	13"	31"	6"	20"
32"	13.5"	33"	6.5"	21.5"

Note : Size may varies +/-5% from the above mentioned chart.

- 170gsm | 5.01oz (UDF2201)
- 160gsm | 4.72oz (THE REST)

COLORS SELECTION





UDF0126
TIFFANY BLUE



ULTIFRESH PERFORMANCE

UDF01 CREW NECK T-SHIRT (UNISEX)

- 100% Performance Dri-Fit Polyester
- Microfiber Polyester Eyelet
- Anti Bacterial & Anti Odor Finishing
- Self Fabric Collar
- Eco Friendly & Water Saving

Size	Shoulder	Chest	Sleeve	Length
2XS	15"	34"	7"	25"
XS	16"	36"	7.5"	26"
S	17"	38"	8"	27"
M	18"	40"	8.5"	28"
L	19"	42"	9"	29"
XL	20"	44"	9.5"	30"
2XL	21"	46"	10"	31"
3XL	22"	48"	10.5"	32"
5XL	24"	52"	11.5"	33.5"

Note : Size may varies +/-5% from the above mentioned chart.

- 170gsm | 5.01oz (UDF0101)
- 160gsm | 4.72oz (THE REST)

COLORS SELECTION

UDF0101 PEARL WHITE UDF0102 ONYX BLACK UDF0103 NAVY BLUE UDF0104 CRIMSON RED UDF0105 MAROON RED UDF0106 LIGHT GREY UDF0107 IRON GREY

UDF0108 TURQUOISE UDF0109 MAGENTA PINK UDF0110 LIGHT BLUE UDF0111 ADMIRAL BLUE UDF0112 ROYAL BLUE UDF0113 ORANGE UDF0114 NEON PINK

UDF0116 BANANA UDF0117 TUSCAN YELLOW UDF0118 LIME GREEN UDF0119 EMERALD GREEN UDF0120 ARMY GREEN UDF0121 BASIL GREEN UDF0122 BARLEY BEIGE

UDF0123 ROYAL PURPLE UDF0124 NEON YELLOW UDF0125 NEON ORANGE UDF0126 TIFFANY BLUE **NEW** UDF0127 FOREST GREEN **NEW** UDF0128 LIGHT PINK **NEW**



ULTIFRESH PERFORMANCE

UDF26

CREW NECK LONG SLEEVE T-SHIRT (UNISEX)

Size	Shoulder	Chest	Sleeve	Length
2XS	15"	34"	19"	25"
XS	16"	36"	20"	26"
S	17"	38"	21"	27"
M	18"	40"	22"	28"
L	19"	42"	23"	29"
XL	20"	44"	23.5"	30"
2XL	21"	46"	23.5"	31"
3XL	22"	48"	23.5"	32"
5XL	24"	52"	24.5"	33.5"

Note : Size may varies +/-5% from the above mentioned chart.

• 160gsm | 4.72oz

- 100% Performance Dri-Fit Polyester
- Microfiber Polyester Eyelet
- Eco Friendly & Water Saving

COLORS SELECTION



UDF2601
PEARL WHITE



UDF2602
ONYX BLACK



UDF2603
NAVY BLUE



UDF2604
CRIMSON RED
NEW



UDF2607
IRON GREY



UDF2610
LIGHT BLUE
NEW



UDF2612
ROYAL BLUE
NEW



UDF2613
ORANGE



UDF2621
BASIL GREEN



ULTIFRESH PERFORMANCE

UDF27

POLO LONG SLEEVE T-SHIRT (UNISEX)

Size	Shoulder	Chest	Sleeve	Length
2XS	15"	34"	19"	25"
XS	16"	36"	20"	26"
S	17"	38"	21"	27"
M	18"	40"	22"	28"
L	19"	42"	23"	29"
XL	20"	44"	23.5"	30"
2XL	21"	46"	23.5"	31"
3XL	22"	48"	23.5"	32"
5XL	24"	52"	24.5"	33.5"

Note : Size may varies +/-5% from the above mentioned chart.

• 160gsm | 4.72oz

- 100% Performance Dri-Fit Polyester
- Microfiber Polyester Eyelet
- Eco Friendly & Water Saving

COLORS SELECTION



UDF2701
PEARL WHITE



UDF2702
ONYX BLACK



UDF2703
NAVY BLUE



UDF2705
MAROON RED



UDF2707
IRON GREY



UDF2710
LIGHT BLUE



UDF2712
ROYAL BLUE



UDF2713
ORANGE



UDF2721
BASIL GREEN



**UDF0509
MAGENTA PINK**

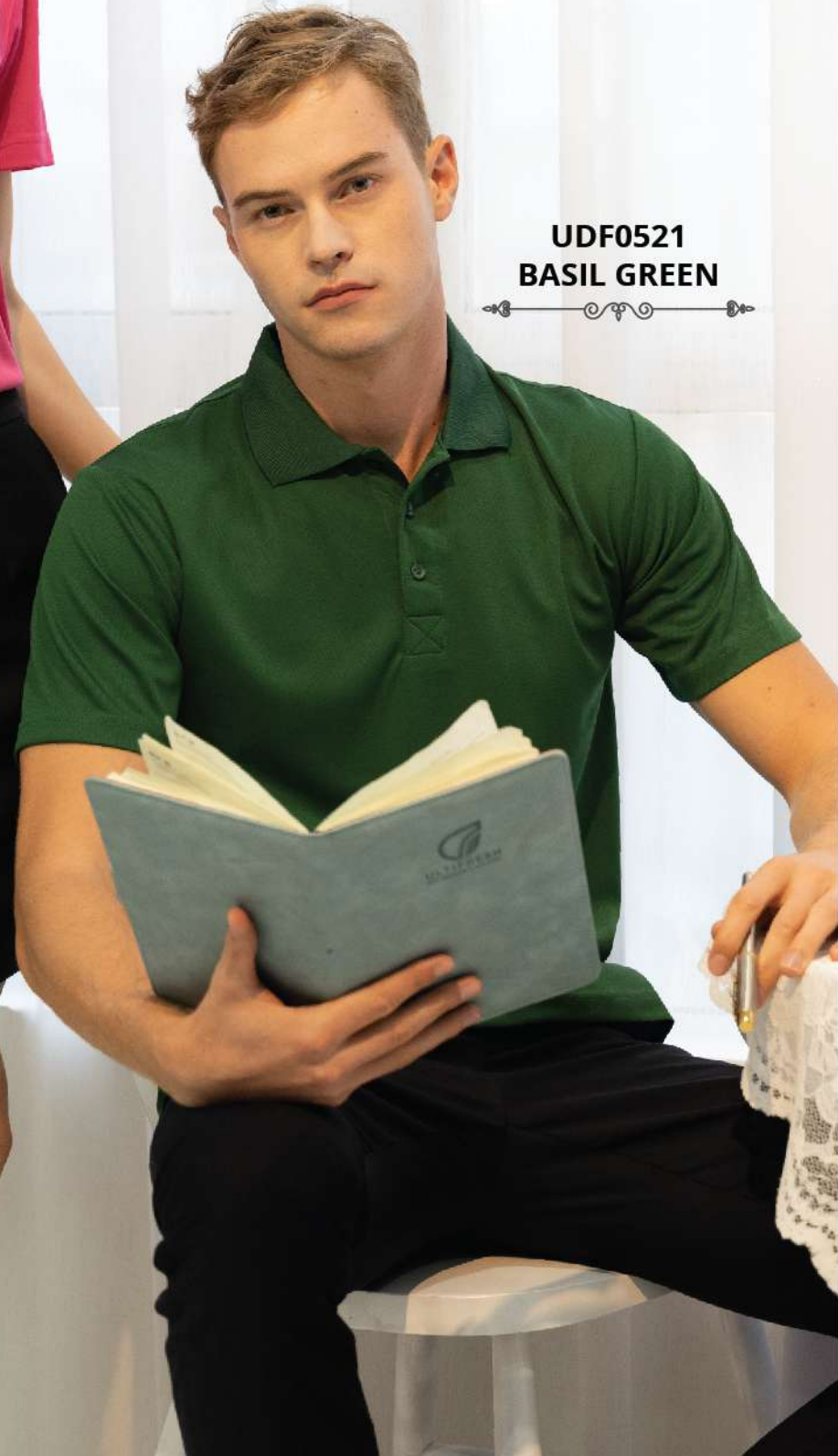

**UDF0521
BASIL GREEN**

UDF05 POLO T-SHIRT (UNISEX)

- 100% Performance Dri-Fit Polyester
- Microfiber Polyester Eyelet
- Anti Bacterial & Anti Odor Finishing
- Self Fabric Collar
- Eco Friendly & Water Saving
- 170gsm | 5.01oz (UDF0501)
- 160gsm | 4.72oz (THE REST)

Size	Shoulder	Chest	Sleeve	Length
2XS	15"	34"	7"	25"
XS	16"	36"	7.5"	26"
S	17"	38"	8"	27"
M	18"	40"	8.5"	28"
L	19"	42"	9"	29"
XL	20"	44"	9.5"	30"
2XL	21"	46"	10"	31"
3XL	22"	48"	10.5"	32"
5XL	24"	52"	11.5"	33.5"

Note : Size may varies +/-5% from the above mentioned chart.

COLORS SELECTION



NEW



ULTIFRESH PERFORMANCE

NEW UDF02 SPORTS SINGLET (UNISEX)

- 100% Dri-Fit Polyester
- Interlock Weave
- Moisture Wicking & Sweat Absorbent
- Eco Friendly & Water Saving

Size	Shoulder	Chest	Length
2XS	15.5"	34"	24"
XS	16"	36"	24.5"
S	16.5"	38"	25"
M	17"	40"	25.5"
L	17.5"	41"	26"
XL	18"	42"	26.5"
2XL	18"	44"	27"
3XL	18.5"	46"	28"
5XL	19.5"	50"	29"

Note : Size may varies +/-5% from the above mentioned chart.

COLORS SELECTION



UDF0201
PEARL WHITE



UDF0202
ONYX BLACK



UDF0203
NAVY BLUE



UDF0204
CRIMSON RED



UDF0205
MAROON RED



UDF0207
IRON GREY



UDF0212
ROYAL BLUE



UDF0221
BASIL GREEN



ULTIFRESH PERFORMANCE

NEW UDF06 SPORTS SHORTS (UNISEX)

- 100% Dri-Fit Polyester
- Interlock Weave
- Moisture Wicking & Sweat Absorbent
- Eco Friendly & Water Saving

• 150gsm | 4.42oz

Size	Waist	Length
2XS	28"	14.5"
XS	29"	15"
S	31"	15.5"
M	32"	16"
L	34"	17"
XL	36"	17.5"
2XL	37"	18"
3XL	38"	19"
5XL	40"	19"

Note : Size may varies +/-5% from the above mentioned chart.

COLORS SELECTION



UDF0601
PEARL WHITE



UDF0602
ONYX BLACK



UDF0603
NAVY BLUE



Anti Bacterial & Anti-Odor Finishing

Self Fabric Collar



UDF07 SIDE PANEL CREW NECK T-SHIRT (UNISEX)

- 100% Dri-Fit Polyester
- Interlock Weave
- Moisture Wicking & Sweat Absorbent
- Eco Friendly & Water Saving

ULTIFRESH CONTRAST

Size	Shoulder	Chest	Sleeve	Length
2XS	15"	34"	7"	25"
XS	16"	36"	7.5"	26"
S	17"	38"	8"	27"
M	18"	40"	8.5"	28"
L	19"	42"	9"	29"
XL	20"	44"	9.5"	30"
2XL	21"	46"	10"	31"
3XL	22"	48"	10.5"	32"
5XL	24"	52"	11.5"	33.5"

Note : Size may varies +/-5% from the above mentioned chart.

• 160gsm | 4.72oz

COLORS SELECTION



UDF0701
WHITE + ORANGE



UDF0702
BLACK + WHITE



UDF0703
NAVY + WHITE



UDF0710
LIGHT BLUE + WHITE



UDF0723
PURPLE + WHITE



UDF0733
BLUE + ORANGE



Contrast Color Piping with Raglan Sleeve Cut



Anti-Bacterial & Anti-Odor Finishing

ULTIFRESH CONTRAST

UDP08 VOV PIPING CREW NECK T-SHIRT (UNISEX)

- 100% Dri-Fit Polyester
- Eyelet Weave
- Moisture Wicking & Sweat Absorbent
- Eco Friendly & Water Saving

Size	Chest	Sleeve	Length
2XS	34"	7"	25"
XS	36"	7.5"	26"
S	38"	8"	27"
M	40"	8.5"	28"
L	42"	9"	29"
XL	44"	9.5"	30"
2XL	46"	10"	31"
3XL	48"	10.5"	32"
5XL	52"	11.5"	33.5"

Note : Size may varies +/-5% from the above mentioned chart.

- 170gsm | 5.01oz (UDP0801)
- 160gsm | 4.72oz (THE REST)

COLORS SELECTION



UDP0801
WHITE + BLACK



UDP0802
BLACK + RED



UDP0807
DARK GREY + WHITE



UDP0813
ORANGE + BLACK



Anti Bacterial
& Anti-Odor
Finishing

Contrast
Side Panel



UDF13 CS SASH POLO T-SHIRT (UNISEX)

- 100% Dri-Fit Polyester
- Interlock Weave
- Moisture Wicking & Sweat Absorbent
- Eco Friendly & Water Saving

ULTIFRESH CONTRAST

Size	Shoulder	Chest	Sleeve	Length
2XS	15"	34"	7"	25"
XS	16"	36"	7.5"	26"
S	17"	38"	8"	27"
M	18"	40"	8.5"	28"
L	19"	42"	9"	29"
XL	20"	44"	9.5"	30"
2XL	21"	46"	10"	31"
3XL	22"	48"	10.5"	32"
5XL	24"	52"	11.5"	33.5"

Note : Size may varies +/-5% from the above mentioned chart.

• 160gsm | 5.64oz

COLORS SELECTION



UDF1301
WHITE + GREEN
+ DARK GREY



UDF1302
BLACK + RED



UDF1306
LIGHT GREY +
WHITE + BLUE



UDF1307
DARK GREY +
WHITE + BLUE



Anti Bacterial
& Anti-Odor
Finishing

Contrast
Shoulder Panel



UDF19 T MAX POLO T-SHIRT (UNISEX)

- 100% Dri-Fit Polyester
- Interlock Weave
- Moisture Wicking & Sweat Absorbent
- Eco Friendly & Water Saving

ULTIFRESH CONTRAST

Size	Shoulder	Chest	Sleeve	Length
2XS	15"	34"	7"	25"
XS	16"	36"	7.5"	26"
S	17"	38"	8"	27"
M	18"	40"	8.5"	28"
L	19"	42"	9"	29"
XL	20"	44"	9.5"	30"
2XL	21"	46"	10"	31"
3XL	22"	48"	10.5"	32"
5XL	24"	52"	11.5"	33.5"

Note : Size may varies +/-5% from the above mentioned chart.

- 160gsm | 5.64oz

COLORS SELECTION



UDF1902
BLACK + RED



UDF1906
GREY + LIGHT BLUE



UDF1912
ROYAL BLUE + GREY



UDF1930
GREEN + WHITE



UDF20 ZIP UP COLLAR POLO T-SHIRT (UNISEX)

- 100% Dri-Fit Polyester
- Interlock Weave
- Contrast Piping
- Moisture Wicking & Sweat Absorbent
- Eco Friendly & Water Saving

ULTIFRESH ORIENTAL

Size	Shoulder	Chest	Sleeve	Length
2XS	15"	34"	7"	25"
XS	16"	36"	7.5"	26"
S	17"	38"	8"	27"
M	18"	40"	8.5"	28"
L	19"	42"	9"	29"
XL	20"	44"	9.5"	30"
2XL	21"	46"	10"	31"
3XL	22"	48"	10.5"	32"
5XL	24"	52"	11.5"	33.5"

Note : Size may varies +/-5% from the above mentioned chart.

• 160gsm | 5.64oz

COLORS SELECTION



UDF2001
WHITE + YELLOW



UDF2002
BLACK + RED



UDF2003
DARK BLUE
+ ROYAL BLUE



UDF2004
RED + BLACK



UDF2010
LIGHT BLUE + WHITE



UDF2013
ORANGE + WHITE



UDF2027
WHITE + RED





Anti Bacterial & Anti-Odor Finishing

Edge Cut & Sewn Design



UDF17 EDGE CREW NECK T-SHIRT (UNISEX)

- 47% Performance Polyester
- 47% Melange Dri-Fit +6% Spandex
- Moisture Wicking & Sweat Absorbent
- Eco-Friendly & Water Saving

ULTIFRESH HEATHER

Size	Shoulder	Chest	Sleeve	Length
2XS	15"	34"	7"	25"
XS	16"	36"	7.5"	26"
S	17"	38"	8"	27"
M	18"	40"	8.5"	28"
L	19"	42"	9"	29"
XL	20"	44"	9.5"	30"
2XL	21"	46"	10"	31"
3XL	22"	48"	10.5"	32"
5XL	24"	52"	11.5"	33.5"

Note : Size may varies +/-5% from the above mentioned chart.

COLORS SELECTION



UDF1702
ONYX BLACK



UDF1703
NAVY BLUE



UDF1706
LIGHT GREY



UDF1710
LIGHT BLUE



UDF1712
ROYAL BLUE



GOLD
SERIES AVAILABLE

Intertek
Total Quality. Assured.

SGS
TEST REPORT



UCP11
MINIMALIST POLO T-SHIRT
(UNISEX)

- 50% Polyester + 50% Cotton
- Outer Polyester + Inner Cotton
- Moisture Wicking & Sweat Absorbent
- Eco-Friendly & Water Saving

ULTIFRESH
HYBRID

Size	Shoulder	Chest	Sleeve	Length
2XS	15"	34"	7"	25"
XS	16"	36"	7.5"	26"
S	17"	38"	8"	27"
M	18"	40"	8.5"	28"
L	19"	42"	9"	29"
XL	20"	44"	9.5"	30"
2XL	21"	46"	10"	31"
3XL	22"	48"	10.5"	32"
5XL	24"	52"	11.5"	33.5"

Note : Size may varies +/-5% from the above mentioned chart.

- 180gsm | 6.35oz

COLORS SELECTION



UCP1101
WHITE + BLACK



UCP1102
BLACK + WHITE



UCP1103
NAVY + WHITE



UCP1105
MAROON + BLACK

NEW



UCP1129
BLACK + GOLD

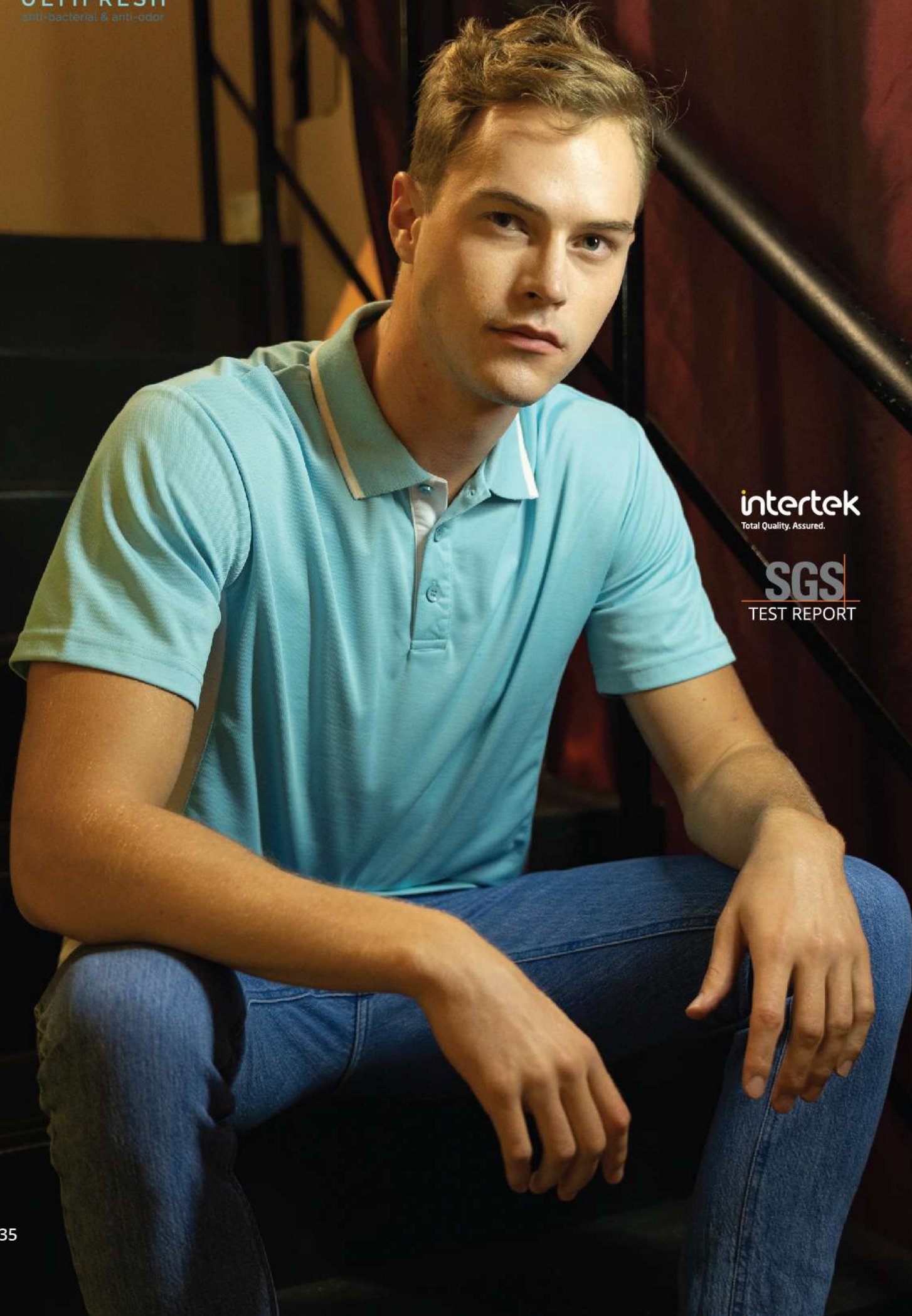

intertek
Total Quality. Assured.

SGS
TEST REPORT

ULTIFRESH HYBRID

Anti Bacterial
& Anti-Odor
Finishing

Contrast Collar
Rib & Panels



Size	Shoulder	Chest	Sleeve	Length
2XS	15"	34"	7"	25"
XS	16"	36"	7.5"	26"
S	17"	38"	8"	27"
M	18"	40"	8.5"	28"
L	19"	42"	9"	29"
XL	20"	44"	9.5"	30"
2XL	21"	46"	10"	31"
3XL	22"	48"	10.5"	32"
5XL	24"	52"	11.5"	33.5"

Note : Size may varies +/-5% from the above mentioned chart.

• 190gsm | 6.70oz

UCP13 CONTRA POLO T-SHIRT (UNISEX)

- 50% Polyester + 50% Cotton
- Outer Polyester + Inner Cotton
- Moisture Wicking & Sweat Absorbent
- Eco-Friendly & Water Saving

COLORS SELECTION



UCP1301
WHITE + GREY



UCP1307
GREY + RED



UCP1310
LIGHT BLUE + WHITE



UCP1334
WHITE + GREEN



UCP1335
WHITE + LIGHT BLUE

ULTIFRESH DOUBLE PIQUE



UH27 PREMIUM PLAIN POLO T-SHIRT (UNISEX)

- 60% Polyester + 40% Cotton
- Moisture Wicking & Sweat Absorbent
- Eco Friendly & Water Saving
- 220gsm | 7.76oz

ULTIFRESH
anti-bacterial & anti-odor

SGS
TEST REPORT

intertek
Total Quality. Assured.

Size	Shoulder	Chest	Sleeve	Length
2XS	15"	34"	7"	25"
XS	16"	36"	7.5"	26"
S	17"	38"	8"	27"
M	18"	40"	8.5"	28"
L	19"	42"	9"	29"
XL	20"	44"	9.5"	30"
2XL	21"	46"	10"	31"
3XL	22"	48"	10.5"	32"
4XL	23"	50"	11"	33"
5XL	24"	52"	11.5"	33.5"

Note : Size may varies +/-5% from the above mentioned chart.

COLORS SELECTION



UH2701
WHITE
NEW



UH2702
BLACK



UH2706
LIGHT GREY



UH2707
DARK GREY



UH2712
NAVY BLUE

ULTIFRESH DOUBLE PIQUE



UH02 FD TWIN TIPPED POLO T-SHIRT (UNISEX)

- 60% Polyester + 40% Cotton
- Dual Stripe Design
- Moisture Wicking & Sweat Absorbent
- Eco-Friendly & Water Saving

Size	Shoulder	Chest	Sleeve	Length
2XS	15"	34"	7"	25"
XS	16"	36"	7.5"	26"
S	17"	38"	8"	27"
M	18"	40"	8.5"	28"
L	19"	42"	9"	29"
XL	20"	44"	9.5"	30"
2XL	21"	46"	10"	31"
3XL	22"	48"	10.5"	32"
4XL	23"	50"	11"	33"
5XL	24"	52"	11.5"	33.5"

Note : Size may varies +/-5% from the above mentioned chart.



220gsm | 7.76oz



UH0202
BLACK



UH0206
LIGHT GREY



UH0207
DARK GREY



UH0212
NAVY BLUE



220gsm | 7.76oz



UH0301
WHITE + NAVY + RED



UH0302
BLACK + GREY + RED



UH0307
NAVY + GREY + RED



UH0330
LIGHT GREY + BLACK + RED

ULTIFRESH DOUBLE PIQUE



UH03 ACE COLLAR POLO T-SHIRT (UNISEX)

- 60% Polyester + 40% Cotton
- Dual Stripe Design
- Moisture Wicking & Sweat Absorbent
- Eco-Friendly & Water Saving

Size	Shoulder	Chest	Sleeve	Length
2XS	15"	34"	7"	25"
XS	16"	36"	7.5"	26"
S	17"	38"	8"	27"
M	18"	40"	8.5"	28"
L	19"	42"	9"	29"
XL	20"	44"	9.5"	30"
2XL	21"	46"	10"	31"
3XL	22"	48"	10.5"	32"
5XL	24"	52"	11.5"	33.5"

Note : Size may varies +/-5% from the above mentioned chart.



ULTIFRESH BOMBER

Anti Bacterial
& Anti-Odor
Finishing

Matching
Collar Rib



UVJ01

ZIP UP JACKET (UNISEX)

- 100% Performance Dry-Fit Polyester
- 100% Polyester Inner Lining
- Moisture Wicking & Sweat Absorbent
- Eco-Friendly & Water Saving

Size	Shoulder	Chest	Sleeve	Length
2XS	16"	37"	21.5"	25"
XS	17"	39"	22.5"	26"
S	18"	41"	23.5"	27"
M	18.5"	43"	24"	28"
L	19"	45"	25"	29"
XL	20"	47"	25.5"	30"
2XL	21"	49"	26.5"	31"
3XL	22"	51"	27"	32"
4XL	23"	53"	27.5"	33"
5XL	24"	55"	28"	34"

Note : Size may varies +/-5% from the above mentioned chart.

- Shell : 55gsm | 1.94oz
- Inner : 160gsm | 5.64oz



COLORS SELECTION



UVJ0102
BLACK



UVJ0103
NAVY



UVJ0105
MAROON



UVJ0120
OLIVE



UVJ0128
ORANGE





Anti Bacterial & Anti-Odor Finishing

Zip Up Collar Design



UVJ03

ZIP UP JACKET (UNISEX)

- 92% Polyester & 8% Spandex
- Side Zip Pocket
- Matching Collar Rib
- Moisture Wicking & Sweat Absorbent
- Eco-Friendly & Water Saving

ULTIFRESH FULL MOON

Size	Shoulder	Chest	Sleeve	Length
2XS	16"	37"	21.5"	25"
XS	17"	39"	22.5"	26"
S	18"	41"	23.5"	27"
M	18.5"	43"	24"	28"
L	19"	45"	25"	29"
XL	20"	47"	25.5"	30"
2XL	21"	48"	26.5"	31"
3XL	22"	51"	27"	32"
4XL	23"	53"	27.5"	33"

Note : Size may varies +/-5% from the above mentioned chart.

- 280gsm | 8.26oz

COLORS SELECTION



UVJ0302
BLACK



UVJ0303
NAVY



UVJ0307
LIGHT GREY



Anti Bacterial & Anti-Odor Finishing Double Striped Rib (Sleeve, Collar & Hem)



UVJ05
VARSITY JACKET (UNISEX)

- 92% Polyester & 8% Spandex
- Color Matching Matt Button
- 2 Front Pockets
- Moisture Wicking & Sweat Absorbent
- Eco-Friendly & Water Saving

ULTIFRESH
VARSITY JACKET

Size	Shoulder	Chest	Sleeve	Length
2XS	16"	37"	22"	23.5"
XS	17"	39"	22.5"	24.5"
S	18"	41"	23.5"	25.5"
M	18.5"	43"	24"	26.5"
L	19.5"	45"	25"	27.5"
XL	20"	47"	25.5"	28.5"
2XL	21"	48"	26.5"	29.5"
3XL	22"	51"	27.5"	30.5"
4XL	23"	53"	28"	31.5"

Note : Size may varies +/-5% from the above mentioned chart.
• 280gsm | 8.26oz

COLORS SELECTION



UVJ0502
BLACK + WHITE



UVJ0503
NAVY BLUE + WHITE



UVJ0504
CRIMSON RED + WHITE



UVJ0512
ROYAL BLUE + WHITE



UVJ0526
BLACK + RED

intertek
Total Quality. Assured.

SGS
TEST REPORT

REUSABLE MASK SERIES

Feels comfy and trendy with the mask ♡



ULTIFRESH
anti-bacterial & anti-odor

URM REUSABLE MASK (ADULT)

Size	Width	Height
Adult	7.5" / 19cm	4.75" / 12cm

Note: Size may vary +/-5% from the above mentioned chart.

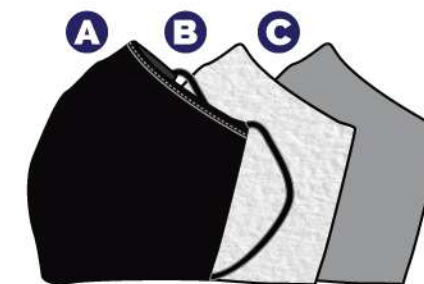
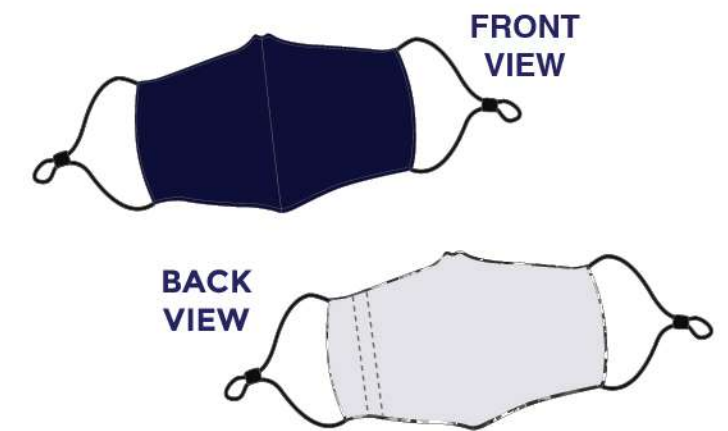

- A. Outer Layer: 99.94% Anti-Bacterial
- B. Center Layer: > 99% BFE Interchangeable Filter Sheet
- C. Inner Layer: 100% Soft Style Cotton

COLORS SELECTION



URM02
BLACK



URM03
NAVY



URM07
DARK GREY



K REUSABLE MASK (KIDS)

Size	Width	Height
Kids	6.5" / 16cm	4.25" / 10.5cm

Note : Size may varies +/-5% from the above mentioned chart.



COLORS SELECTION



**K0
BLACK**



**K1
LIGHT BLUE**



**K2
LITTLE SHEEPS**



**K3
ANIMAL WORLD**



**K4
UNICORN FANTASY**



**K5
DINO WORLD**

FILTER SHEET ADULT & KIDS



- High Strength Melt Blown Fabric Filter Sheet
- BFE >99%
- 10pcs Per Pack



**AVFP10
ADULT FILTER PACK**



**KVFP10
KIDS FILTER PACK**

ANTI-BACTERIAL QUICK-DRY TOWEL



- Anti-Bacterial
- Nylon Chinlon, Polyester
- Compact, Lightweight, Quick-Dry
- Open For Customization Of Logo Webbing

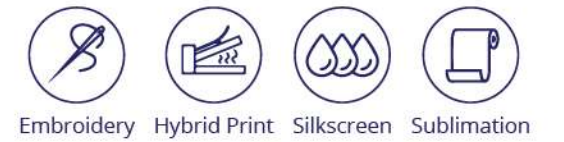

UBTW BATH TOWEL

Length	Width	Weight
55.1"/140cm	29.5"/75cm	220g

Note : Size may varies +/-5% from the above mentioned chart.



UBTW01 PEARL WHITE



UBTW03 NAVY



UBTW05 MAROON



UBTW06 LIGHT GREY



UBTW11 ADMIRAL BLUE



UBTW46 KELLY GREEN

USTW SPORTS TOWEL

Length	Width	Weight
25.6"/65cm	13.8"/35cm	40g

Note : Size may varies +/-5% from the above mentioned chart.



USTW01 PEARL WHITE



USTW03 NAVY



USTW05 MAROON



USTW06 LIGHT GREY



USTW11 ADMIRAL BLUE



USTW46 KELLY GREEN





BEAM
QUALITY APPAREL

**BEAM APPAREL PROMOTES
NEW MINIMALISM**

A concept which allows our daily wear to be something comfortable, contemporary and be worn in nearly all occasions.



Anti Fabric Fur Ball Technology



COLLAR FLEECE

- 100% Polyester Reverse Dual Sided Fleece
- Full Zip Stand Up Collar
- Elastic Sleeve End
- Zip On Both Sided Pocket
- Elastic Cord At Hem For Hem Adjustment



OWC45

ZIP UP JACKET (UNISEX)

Size	Waist	Chest	Sleeve	Length
S	43"	42"	23"	25"
M	44"	44"	24"	26"
L	46"	45"	25"	26"
XL	47"	47"	26"	27"
2XL	49"	48"	26"	28"
3XL	50"	50"	27"	29"

Note : Size may varies +/-5% from the above mentioned chart.

COLORS SELECTION



OWC4502
ONYX BLACK



OWC4504
CRIMSON RED



OWC4512
ROYAL BLUE

• 280gsm | 8.20oz

OWC55

ZIP UP JACKET (FEMALE)

Size	Waist	Chest	Sleeve	Length
S	37"	35"	22"	23"
M	39"	36"	23"	24"
L	40"	38"	23"	25"
XL	42"	39"	24"	26"
2XL	43"	41"	24"	26"
3XL	45"	43"	25"	27"

Note : Size may varies +/-5% from the above mentioned chart.

COLORS SELECTION



OWC5502
ONYX BLACK



OWC5504
CRIMSON RED



OWC5512
ROYAL BLUE

• 280gsm | 8.20oz



BEAM
QUALITY APPAREL

**HDR30
HOODIE WITHOUT ZIP**

Size	Shoulder	Chest	Sleeve	Length
2XS	15"	34"	23"	25"
XS	16"	36"	24.5"	25.5"
S	17"	38"	24.5"	26"
M	18"	41"	25"	27.5"
L	18.5"	43"	26"	29"
XL	19"	46"	27"	30"
2XL	20"	48"	27.5"	31"
3XL	21"	50"	28"	32"
4XL	21.5"	52"	29"	33"

Note : Size may varies +/-5% from the above mentioned chart.
• 220gsm | 6.50oz

Unlined Hood With Matching Drawstring



- Cotton / Polyester Blend
- Kangaroo Pockets With Ribbed Finishing
- Double Needle Cuffs And Waistband For Extra Durability

COLORS SELECTION



HDR3001
PEARL WHITE



HDR3002
ONYX BLACK



HDR3003
NAVY BLUE



HDR3004
CRIMSON RED



HDR3006
LIGHT GREY



BEAM
QUALITY APPAREL

HDR40
HOODIE WITH ZIP

Unlined Hood With Matching Drawstring



Size	Shoulder	Chest	Sleeve	Length
2XS	15"	34"	23"	25"
XS	16"	36"	24.5"	25.5"
S	17"	38"	24.5"	26"
M	18"	41"	25"	27.5"
L	18.5"	43"	26"	29"
XL	19"	46"	27"	30"
2XL	20"	48"	27.5"	31"
3XL	21"	50"	28"	32"
4XL	21.5"	52"	29"	33"

Note : Size may varies +/-5% from the above mentioned chart.

• 220gsm | 6.50oz

- Cotton / Polyester Blend
- Pouch Pockets
- Matching Zip
- Double Needle Cuffs And Waistband For Extra Durability

COLORS SELECTION



HDR4001
PEARL WHITE



HDR4002
ONYX BLACK



HDR4003
NAVY BLUE



HDR4004
CRIMSON RED



HDR4006
LIGHT GREY



BEAM
QUALITY APPAREL

AKJ01

LIGHTWEIGHT MICROFIBER JACKET IN A BAG (PACKABLE)



Unique printed patterns

- 100% Light Weight Polyester
- UPF40 + Coating
- Fully Sewn Built in Hoodie Design
- Packable Drawstring Bag Included
- Come with Unique Pattern Prints in Front Panel

Size	Shoulder	Chest	Sleeve
S	40"	27.5"	25"
M	41"	28.5"	26"
L	43"	29"	26.5"
XL	44"	30"	27"
2XL	46"	31"	28"
3XL	48"	31.5"	29"
4XL	49"	32.5"	29.5"

Note : Size may varies +/-5% from the above mentioned chart.

COLORS SELECTION



AKJ0101
BLACK



AKJ0102
ROYAL BLUE



AKJ0103
LIME GREEN



AKJ0104
ORANGE



AKJ0105
YELLOW



AKJ0106
SKY BLUE



AKJ0107
RED



AKJ0108
BRIGHT PINK



AKJ0110
PINK



AKJ0111
WHITE



ARC10
CLASSIC SOFT
CARDIGAN (UNISEX)

Size	Shoulder	Chest	Sleeve	Length
S	16"	38"	24"	25.5"
M	16.5"	40"	24"	26"
L	17"	42"	24"	27"
XL	17.5"	44"	25"	27.5"
2XL	18"	46"	25"	28"
3XL	18.5"	48"	25"	28.5"
5XL	19.5"	52"	26"	30"

Note : Size may varies +/-5% from the above mentioned chart.



ARS10
CLASSIC V-NECK
SWEATER (UNISEX)

Size	Shoulder	Chest	Sleeve	Length
S	17"	36"	23"	25
M	18"	38"	25"	25.5"
L	19"	40"	25"	26"
XL	20"	41"	25"	27"
2XL	21"	42.5"	26"	28"
3XL	22"	44"	26"	29"
5XL	24"	45.5"	26.5"	30"

Note : Size may varies +/-5% from the above mentioned chart.



ARC1001
DARK GREY



ARC1002
NAVY BLUE



ARC1003
GREEN



ARS1001
DARK GREY



ARS1002
NAVY BLUE



ARS1003
GREEN



ARC1004
BLACK



ARC1005
BROWN



ARC1006
MAROON



ARS1004
BLACK



ARS1005
BROWN



ARS1006
MAROON



BEAM
QUALITY APPAREL

UPT01
POLO T-SHIRT (UNISEX)

- 100% Premium "LACOSTE" Fabric
- Matching Color Button
- Matching Ribbed Collar & Cuffs
- Available In 15 Colors
- XS-3XL Size

Size	Shoulder	Chest	Sleeve	Length
XS	15"	36"	8"	26"
S	16"	38"	8.5"	27"
M	18"	40"	8.5"	28"
L	18"	41"	9"	29"
XL	19"	44"	9"	30"
2XL	20"	44"	9.5"	30.5"
3XL	21"	48"	9.5"	31"

Note : Size may varies +/-5% from the above mentioned chart.

COLORS SELECTION



UPT01-01
WHITE



UPT01-02
BLACK
(READY STOCK)



UPT01-03
NAVY BLUE



UPT01-04
RED



UPT01-05
MAROON



UPT01-11
ROYAL BLUE



UPT01-13
ORANGE



UPT01-17
YELLOW



UPT01-18
LIME GREEN



UPT01-23
PURPLE



UPT01-40
BOTTLE GREEN



UPT01-44
AQUA



UPT01-45
FUSCHIA



UPT01-46
KELLY GREEN



UPT01-47
GREY MELANGE



BEAM
QUALITY APPAREL

USS01
SHORT SLEEVE
T-SHIRT (UNISEX)

- 100% Premium Cotton (Unisex)
- Matching Rib Collar
- Available In 18 Colors
- XS-5XL Size



Size	Shoulder	Chest	Sleeve	Length
XS	15"	36"	7"	26"
S	17"	38"	7.5"	27"
M	18"	40"	7.5"	28"
L	19"	42"	8"	29"
XL	20"	44"	8"	30"
2XL	20.5"	46"	8.5"	31"
3XL	22"	48"	8.5"	31.5"
4XL	23"	50"	9"	32"
5XL	24"	52"	9.5"	33"

Note : Size may varies +/-5% from the above mentioned chart.

COLORS SELECTION



USS01-01
WHITE



USS01-02
BLACK
(READY STOCK)



USS01-03
NAVY BLUE



USS01-04
RED



USS01-05
MAROON



USS01-12
ROYAL BLUE



USS01-13
ORANGE



USS01-17
YELLOW



USS01-18
LIME GREEN



USS01-23
PURPLE



USS01-39
INDIGO BLUE



USS01-40
BOTTLE GREEN



USS01-41
OLIVE



USS01-42
SAND



USS01-43
STONE



USS01-44
AQUA



USS01-45
FUSCHIA



USS01-46
KELLY GREEN



BEAM
QUALITY APPAREL

USSG01
200GSM SHORT SLEEVE T-SHIRT (UNISEX)

Size	Shoulder	Chest	Sleeve	Length
XS	15"	36"	7"	26"
S	17"	38"	7.5"	27"
M	18"	40"	7.5"	28"
L	19"	42"	8"	29"
XL	20"	44"	8"	30"
2XL	20.5"	46"	8.5"	31"
3XL	22"	48"	8.5"	31.5"
4XL	23"	50"	9"	32"
5XL	24"	52"	9.5"	33"

Note : Size may varies +/-5% from the above mentioned chart.



BEAM
QUALITY APPAREL

KSS01
SHORT SLEEVE T-SHIRT (KIDS)

- 100% Premium Cotton
- Matching Ribbed Collar
- Available in 15 Colors
- 2/4 years - 13/14 years

Size	Shoulder	Chest	Sleeve	Length
2-4	11"	24"	5"	17"
5-6	12"	26"	6"	18"
7-8	13"	28"	6.5"	20"
9-10	15"	30"	6.5"	21"
11-12	15"	34"	7"	23"
13-14	17"	36"	7"	24"

- 170gsm-175gsm



Note : Size may varies +/-5% from the above mentioned chart.

- 100% Premium Cotton (Unisex)
- Matching Rib Collar
- XS-5XL Size

COLORS SELECTION



USSG01-01
WHITE



USSG01-02
BLACK
(READY STOCK)



COLORS SELECTION



KSS01-01
WHITE



KSS01-02
BLACK



KSS01-03
NAVY BLUE



KSS01-05
MAROON



KSS01-12
ROYAL BLUE



KSS01-13
ORANGE



KSS01-17
YELLOW



KSS01-18
LIME GREEN



KSS01-23
PURPLE



KSS01-39
INDIGO BLUE



KSS01-40
BOTTLE GREEN



KSS01-41
OLIVE



KSS01-44
AQUA



KSS01-45
FUSCHIA



KSS01-46
KELLY GREEN



BEAM
QUALITY APPAREL

APR10
APRON
100% POLYESTER

- 100% Polyester
- Back Lace Design
- Front Pockets
- Customizable
- Available In 12 Colors
- Free Size
- All Ready Stock

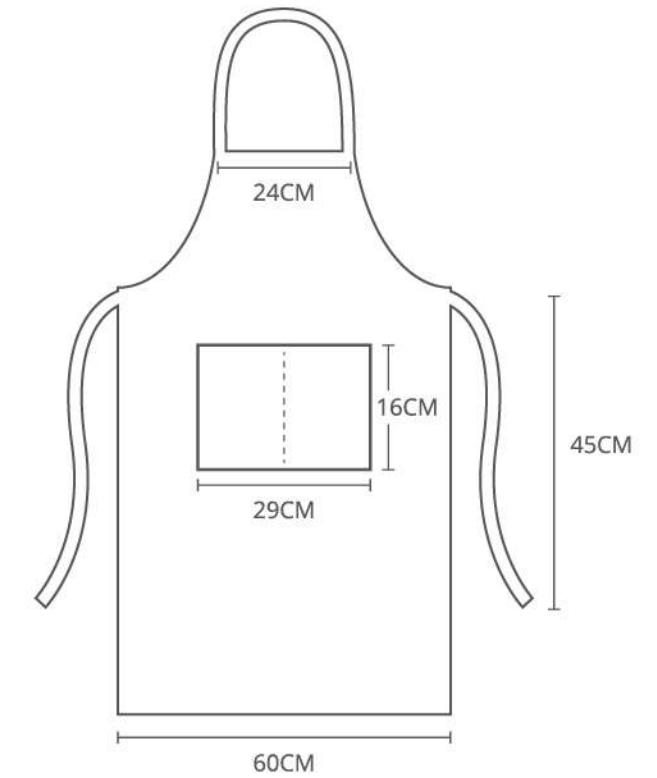

Note: dimension may vary +/- 5% from the above mentioned chart.

COLORS SELECTION





BEAM
QUALITY APPAREL

RGN21
LONG SLEEVE SWEAT
SHIRT (UNISEX)



Size	Shoulder	Chest	Length
2XS	15"	34"	25"
XS	16"	36"	26"
S	17"	39"	26"
M	18"	41"	28"
L	19"	43"	29"
XL	19"	46"	30"
2XL	20"	48"	31"
3XL	21"	50"	32"
4XL	22"	53"	33"

- Cotton / Polyester Blend
- Crew Neck, Long Sleeve Design
- 6 Available Colors
- Double Needle Cuffs and Waistband For Extra Durability

Note : Size may varies +/-5% from the above mentioned chart.

• 220gsm | 6.50oz

COLORS SELECTION



RGN2101
PEARL WHITE



RGN2102
ONYX BLACK



RGN2103
NAVY BLUE



RGN2104
CRIMSON RED



RGN2106
LIGHT GREY



RGN2138
LIGHT PINK



FTL3
OXFORD CORPORATE
SHIRT (UNISEX)



Size	Shoulder	Chest	Sleeve	Length
S (38)	16.5"	37"	21.5"	27"
M (39)	17"	39"	22"	28.5"
L (40)	17"	40"	22"	29"
XL (41)	17.5"	42"	22"	30"
2XL (42)	18"	44"	22.5"	29.5"
3XL (43)	19"	46"	23"	30"
4XL (44)	19"	47"	23'	30"

- Made of 60% Cotton + 40% Oxford Fabric
- Hidden Buttons Behind Collar For An
- Alternate Look
- One Chest Pocket On The Left
- Full Placket Buttons

Note : Size may varies +/-5% from the above mentioned chart.

COLORS SELECTION



FTL301
PEARL WHITE



FTL302
ONYX BLACK



FTL303
NAVY BLUE



FTL306
LIGHT GREY



FTL338
LIGHT PINK



FTL340
LAKE BLUE



BEAM
QUALITY APPAREL

ACS11

**HIGH QUALITY CORPORATE
LONG SLEEVE SHIRT**

- 40% Cotton + 60% Polyester Fabric
- Full Placket Buttons
- Moisture Wicking Technology
- Poplin Finishing
- V-Edge Collar Design With Iron Fusing

UNISEX

Size	Shoulder	Chest	Sleeve	Length
S (38)	16.5"	37"	23"	28"
M (39)	17"	38"	23"	28"
L (40)	18"	39"	23.5"	28.5"
XL (41)	18"	41"	24"	29"
2XL (42)	18.5"	43"	24"	30"
3XL (43)	19.5"	44"	24.5"	31"
4XL (44)	20.5"	47"	25'	32"

Note : Size may varies +/-5% from the above mentioned chart.

- 220gsm | 6.50oz



BEAM
QUALITY APPAREL

FTL 1

**HIGH QUALITY CORPORATE
LONG SLEEVE SHIRT**

FEMALE

Size	Shoulder	Chest	Sleeve	Length
XS (35)	14.5"	35"	21"	22.5"
S (36)	15"	37"	21"	23"
M (37)	15.5"	38"	21.5"	23.5"
L (38)	16"	40"	21.5"	24"
XL (39)	16"	41"	22"	25"
2XL (40)	16.5"	42"	22.5"	25.5"
3XL (41)	17"	44"	23"	26"
5XL (42)	17.5"	47"	23.5'	27"

Note : Size may varies +/-5% from the above mentioned chart.

COLORS SELECTION



ACS110
MAROON RED



ACS111
BLACK



ACS112
LIGHT PINK



77 ACS113
LIGHT BLUE



ACS114
WHITE



COLORS SELECTION



FTL101
WHITE



FTL110
LIGHT BLUE



FTL138
PINK



TCS1

**HIGH QUALITY CORPORATE
SHORT SLEEVE SHIRT**

- 40% Cotton + 60% Polyester Fabric
- Full Placket Buttons
- Moisture Wicking Technology
- Poplin Finishing
- V-Edge Collar Design With Iron Fusing

UNISEX

Size	Shoulder	Chest	Sleeve	Length
S (38)	16.5"	37"	8"	28"
M (39)	17"	38"	8"	28"
L (40)	18"	39"	8.5"	28.5"
XL (41)	18"	41"	8.5"	29"
2XL (42)	18.5"	43"	9"	30"
3XL (43)	19.5"	44"	9"	31"
4XL (44)	20.5"	47"	9.5"	32"

Note : Size may varies +/-5% from the above mentioned chart.

- 220gsm | 6.50oz



FTS 1

**HIGH QUALITY CORPORATE
SHORT SLEEVE SHIRT**

FEMALE

Size	Shoulder	Chest	Sleeve	Length
XSC(35)	14.5"	35"	7.5"	22.5"
S (36)	15"	37"	7.5"	23"
M (37)	15.5"	38"	7.5"	23.5"
L (38)	16"	40"	8"	24"
XL (39)	16"	41"	8"	25"
2XL (40)	16.5"	42"	8.5"	25.5"
3XL (41)	17"	44"	8.5"	26"
5XL (42)	17.5"	47"	9"	27"

Note : Size may varies +/-5% from the above mentioned chart.



COLORS SELECTION



**TCS101
WHITE**



**TCS102
BLACK**



**TCS110
LIGHT BLUE**



COLORS SELECTION



**FTS101
WHITE**



**FTS102
BLACK**



**FTS110
LIGHT BLUE**





**CBM3502
BLACK**

**CBM3503
NAVY BLUE**

- 65% Polyester 35% Rayon
- (Shell) 100% Polyester
- 3 Pocket Flat Collar Design
- Full Suit Available
- Dual Buttons

BEAM
QUALITY APPAREL

PREMIUM

**2 BUTTON FITTED BLAZER
(MALE CUTTING)**

JACKET SIZE CHART

Size	Shoulder	Chest	Sleeve	Length
165/S	16.75"	37.8"	23.2"	25.6"
170/M	17.2"	39.4"	23.8"	26.4"
175/L	17.7"	41"	24.4"	27"
180/XL	18.2"	42.5"	24.8"	28"
185/2XL	18.6"	44"	25.4"	28.7"
190/3XL	19"	45.6"	26"	29.5"
195/4XL	19.6"	47.2"	25.5'	30.3"

Note : Size may varies +/-5% from the above mentioned chart.



**PAT0102
BLACK**

**PAT0103
NAVY BLUE**

PANT SIZE CHART

Size	Waist	Hip	Length
165/S	29"	36.2"	39.3"
170/M	30"	37.4"	40"
175/L	31.5"	38.5"	41"
180/XL	32.6"	40"	41.7"
185/2XL	34"	41.3"	42.5"
190/3XL	35.8"	43"	42.5"
195/4XL	37.4"	44.5"	42.5"

Note : Size may varies +/-5% from the above mentioned chart.



Classic Button Down
Back Pocket

Elastic Waist Band
Design



BEAM
QUALITY APPAREL

PREMIUM

**2 BUTTON FITTED BLAZER
(FEMALE CUTTING)**



**CBM2502
BLACK**

**CBM2503
NAVY BLUE**

- 65% Polyester 35% Rayon
- (Shell) 100% Polyester
- 3 Pocket Flat Collar Design
- Full Suit Available
- Dual Buttons

JACKET SIZE CHART

Size	Shoulder	Chest	Sleeve	Length
155/XS	14"	33"	22"	21.8"
160/S	14.5"	34.6"	22"	21.8"
165/M	15"	36"	22.4"	22.6"
170/L	15.3"	37.8"	22.8"	23.4"
175/XL	15.7"	39.4"	23.2"	24.2"
180/2XL	16"	41"	23.6"	25"
185/3XL	16.5"	42.5"	23.6"	25"
190/4XL	17"	44"	23.6"	25"

Note : Size may varies +/-5% from the above mentioned chart.



**SKT0202
BLACK**

**SKT0203
NAVY BLUE**

PANT SIZE CHART

Size	Waist	Hip	Length
155/XS	24.8"	33"	18"
160/S	26.3"	34.6"	18.3"
165/M	27.5"	36.2"	18.5"
170/L	29"	37.8"	19.7"
175/XL	30"	39.3"	19"
180/2XL	32.2"	41"	19"
185/3XL	33.8"	42.5"	19.3"
190/4XL	35.4"	44"	19.3"

Note : Size may varies +/-5% from the above mentioned chart.



Classic Button Down
Back Pocket



Elastic Waist Band
Design



PROMOTIONAL SERIES

LIMITED SIZES & QUANTITY

ULTIFRESH PERFORMANCE



UDF12 CREW NECK T-SHIRT (FEMALE)

Size	Shoulder	Chest	Sleeve	Length
S	13"	32"	6"	22.5"
M	14"	34"	6.5"	23.5"
L	15"	36"	6.5"	24.5"
XL	16"	38"	7"	25.5"
2XL	17"	40"	7"	26.5"

Note : Size may varies +/-5% from the above mentioned chart.

- 170gsm | 5.01oz (UDF1201)
- 160gsm | 4.72oz (THE REST)

- 100% Performance Dri-Fit Polyester
- Microfiber Polyester Eyelet
- Eco-Friendly & Water Saving



COLORS SELECTION



UDF1201 PEARL WHITE



UDF1202 ONYX BLACK



UDF1203 NAVY BLUE



UDF1204 CRIMSON RED



UDF1212 ROYAL BLUE



UDF1213 ORANGE



UDF1216 BANANA



UDF1223 ROYAL PURPLE



ULTIFRESH PERFORMANCE



UDF18 POLO T-SHIRT (FEMALE)

Size	Shoulder	Chest	Sleeve	Length
S	13"	32"	6"	22.5"
M	14"	34"	6.5"	23.5"
L	15"	36"	6.5"	24.5"
XL	16"	38"	7"	25.5"
2XL	17"	40"	7"	26.5"

Note : Size may varies +/-5% from the above mentioned chart.

• 160gsm | 4.72oz (THE REST)



- 100% Performance Dri-Fit Polyester
- Microfiber Polyester Eyelet
- Eco-Friendly & Water Saving

COLORS SELECTION



UDF1812
ROYAL BLUE



UDF1813
ORANGE



UDF1816
BANANA



UDF1823
ROYAL PURPLE



ULTIFRESH HYBRID

Size	Shoulder	Chest	Sleeve	Length
S	13"	32"	6"	22.5"
M	14"	34"	6.5"	23.5"
L	15"	36"	6.5"	24.5"
XL	16"	38"	7"	25.5"

Note : Size may varies +/-5% from the above mentioned chart.

• 190gsm | 6.70oz

UCP23

CONTRA POLO T-SHIRT (FEMALE)

- 50% Polyester + 50% Cotton
- Outer Polyester + Inner Cotton

- Moisture Wicking & Sweat Absorbent
- Eco Friendly & Water Saving

COLORS SELECTION



UCP2301
WHITE + GREY



UCP2307
GREY + RED



UCP2310
LIGHT BLUE + WHITE



UCP2334
WHITE + GREEN



UCP2335
WHITE + LIGHT BLUE

Anti Bacterial
& Anti-Odor
Finishing

Zip Up
Collar Design



UDF28
ZIP UP COLLAR POLO
T-SHIRT (FEMALE)

ULTIFRESH
ORIENTAL

Size	Shoulder	Chest	Sleeve	Length
S	13"	32"	6"	22.5"
M	14"	34"	6.5"	23.5"
L	15"	36"	6.5"	24.5"
XL	16"	38"	7"	25.5"

Note : Size may varies +/-5% from the above mentioned chart.

- 190gsm | 6.70oz
- 100% Dri-Fit Polyester
- Interlock Weave
- Contrast Piping
- Moisture Wicking & Sweat Absorbent
- Eco Friendly & Water Saving

Anti Bacterial
& Anti-Odor
Finishing

Double
Pique Knit



ULTIFRESH
DOUBLE PIQUE

UH12
FD TWIN TIPPED POLO
T-SHIRT (FEMALE)

Size	Shoulder	Chest	Sleeve	Length
S	13"	32"	6"	22.5"
M	14"	34"	6.5"	23.5"
L	15"	36"	6.5"	24.5"
XL	16"	38"	7"	25.5"

Note : Size may varies +/-5% from the above mentioned chart.

- 60% Polyester + 40% Cotton
- Dual Stripe Design

- Moisture Wicking & Sweat Absorbent
- Eco-Friendly & Water Saving

COLORS SELECTION



UDF2801
WHITE + YELLOW



UDF2802
BLACK + RED



UDF2804
RED + BLACK



UDF2810
LIGHT BLUE + WHITE



UDF2813
ORANGE + WHITE



UDF2827
WHITE + RED



UH1202
BLACK



UH1206
LIGHT GREY



UH1207
DARK GREY



UH1212
NAVY BLUE

COLORS SELECTION



ULTIFRESH CUSTOMIZATION

Create your very own anti-bacterial & anti-odor apparels from scratch with 8-steps customization process! A perfect alternative for brands or institution who wish to incorporate our unique technology to their new or existing apparels design.

